



Nominal data

Type	8312 NHH	
Nominal voltage	VDC	12
Nominal voltage range	VDC	6 .. 15
Speed (rpm)	min ⁻¹	6300
Power consumption	W	5.4
Min. ambient temperature	°C	-20
Max. ambient temperature	°C	75
Air flow	m ³ /h	95
Sound power level	B	6.0
Sound pressure level	dB(A)	48

ml = Max. load · me = Max. efficiency · fa = Free air · cs = Customer specification · ce = Customer equipment
Subject to change

Technical description

Weight	0.16 kg
Dimensions	80 x 80 x 32 mm
Impeller material	Glass-fiber reinforced PA plastic
Housing material	Glass-fiber reinforced PBT plastic
Part no.	9292910116
Airflow direction	Exhaust over struts
Direction of rotation	Counterclockwise, viewed toward rotor
Bearing	Ball bearing
Service life L10 at 40 °C	72500 h
Service life L10 at maximum temperature	27500 h
Cable	With leads AWG 26, TR 64



Product drawing

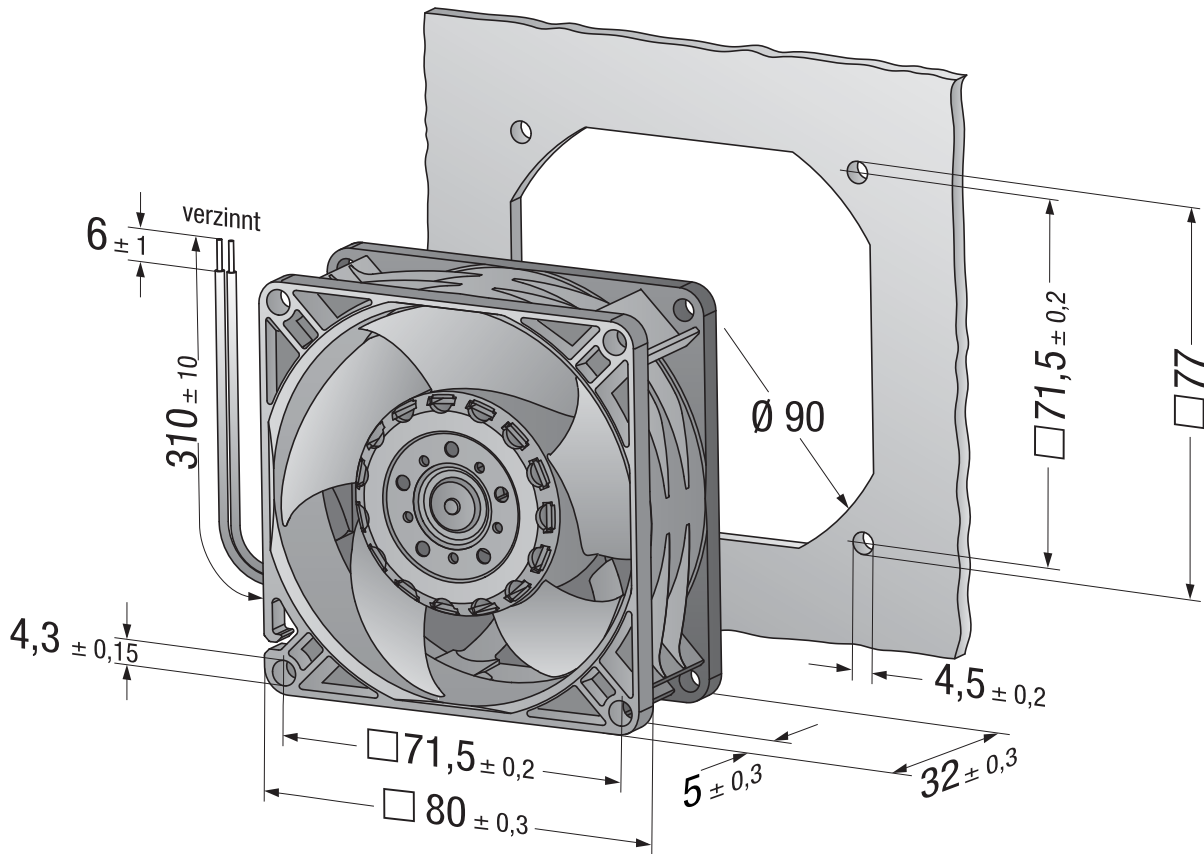

Curves

